

Product SPECIFICATION SHEET

PERANO STEEL ENCLOSURE 450x300x220

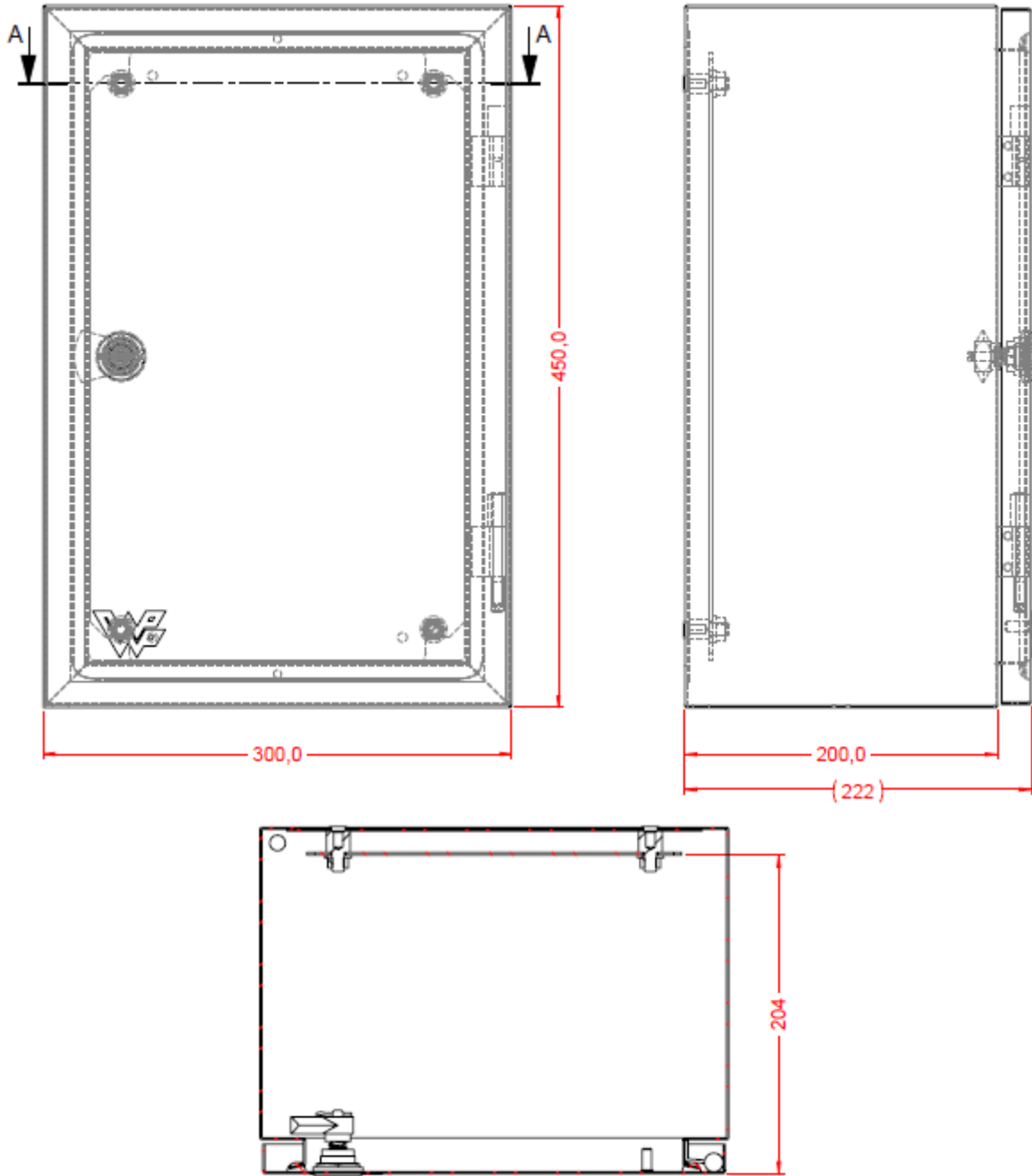

SECTION A-A
SCALE 1 : 3

BRANCH CONTACT DETAILS

Johannesburg	010 202 3300
Germiston	011 418 9600
Cape Town	021 510 0710
Pinetown	031 700 4215
Riverhorse	031 492 4800

NATIONAL CALL CENTRE

Sales 010 202 3400
Technical 010 202 3500

www.acdc.co.za

Product SPECIFICATION SHEET

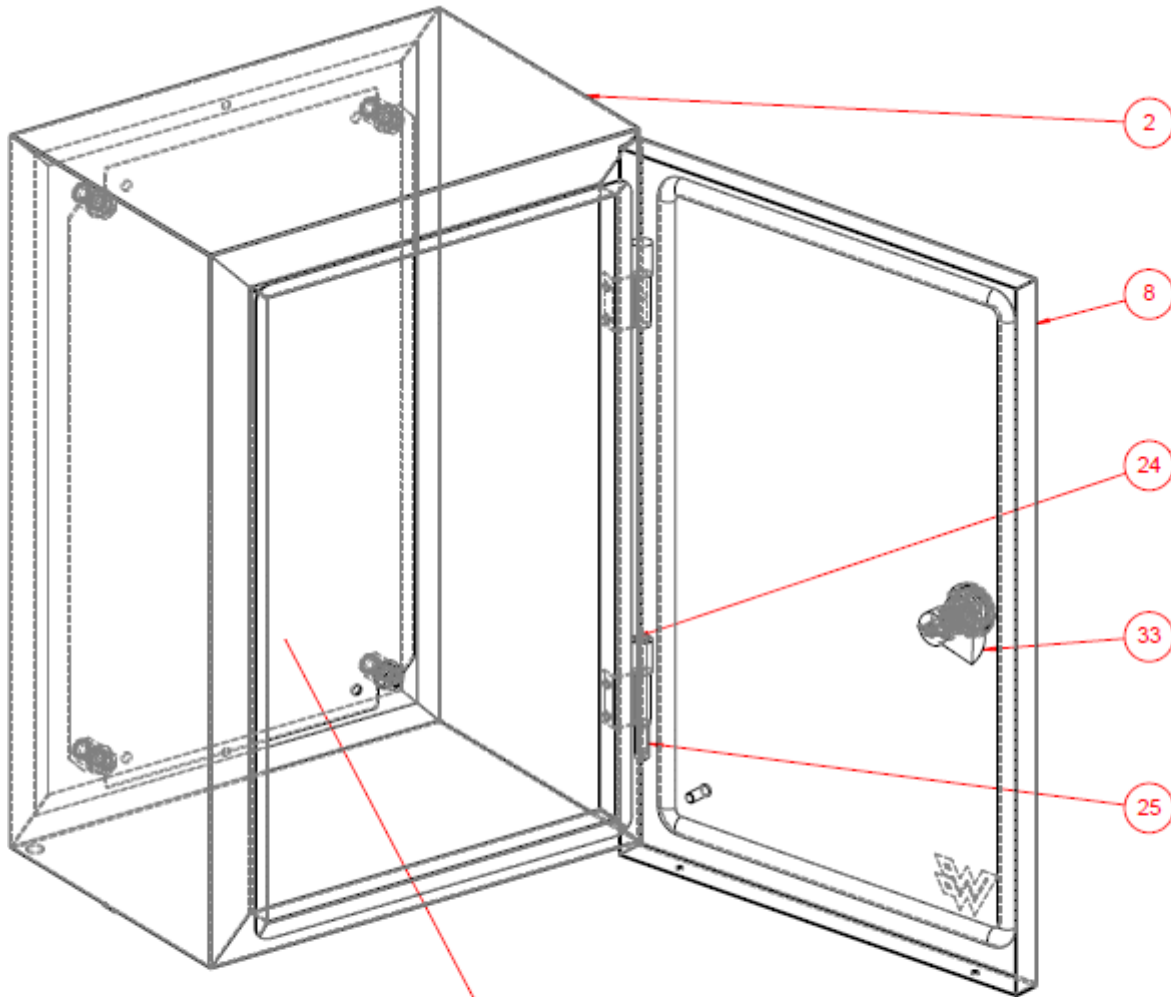

33	25.55.201.01	IP55 PANEL LOCK Ø25	1
32	M8	HEX NUT	4
31	M8	WASHER	4
25	100-23594	PIN RETAINER	1
24	100-24014	HINGE PIN	1
12	210-0542 REV 9	PERANO 102 CHASSIS	1
8	202-5178 REV 1	W.A. DOOR PERANO 102	1
2	202-5169 REV 3	W.A. PERANO 202 MAIN BODY	1
ITEM NO.	PART NUMBER	DESCRIPTION	QTY.

BRANCH CONTACT DETAILS

Johannesburg 010 202 3300
Germiston 011 418 9600
Cape Town 021 510 0710
Pinetown 031 700 4215
Riverhorse 031 492 4800

NATIONAL CALL CENTRE

Sales 010 202 3400
Technical 010 202 3500

www.acdc.co.za