

Product SPECIFICATION SHEET

PERANO STEEL ENCLOSURE 750x550x270

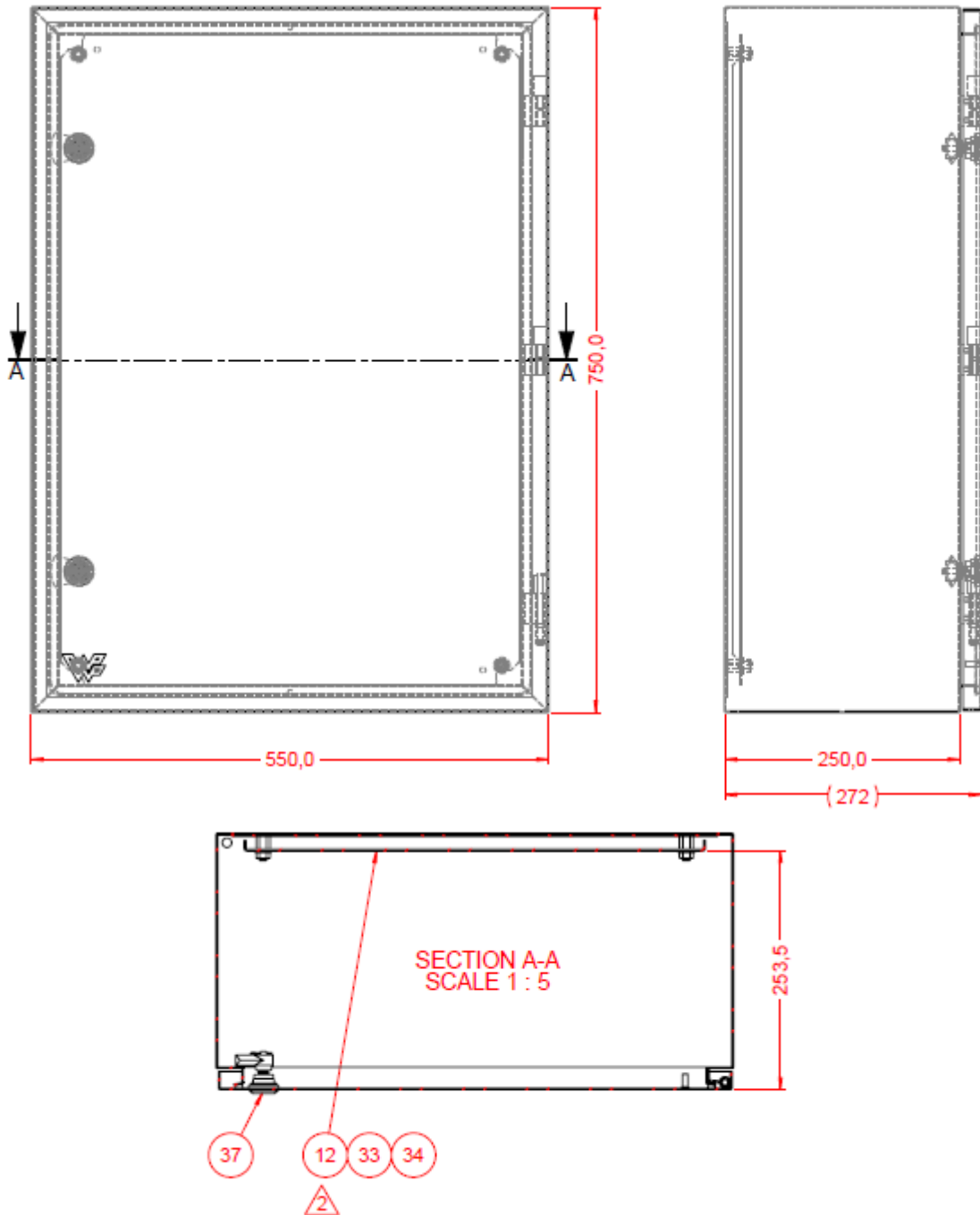

BRANCH CONTACT DETAILS

Johannesburg	010 202 3300
Germiston	011 418 9600
Cape Town	021 510 0710
Pinetown	031 700 4215
Riverhorse	031 492 4800

NATIONAL CALL CENTRE

Sales 010 202 3400
Technical 010 202 3500

www.acdc.co.za

Product SPECIFICATION SHEET

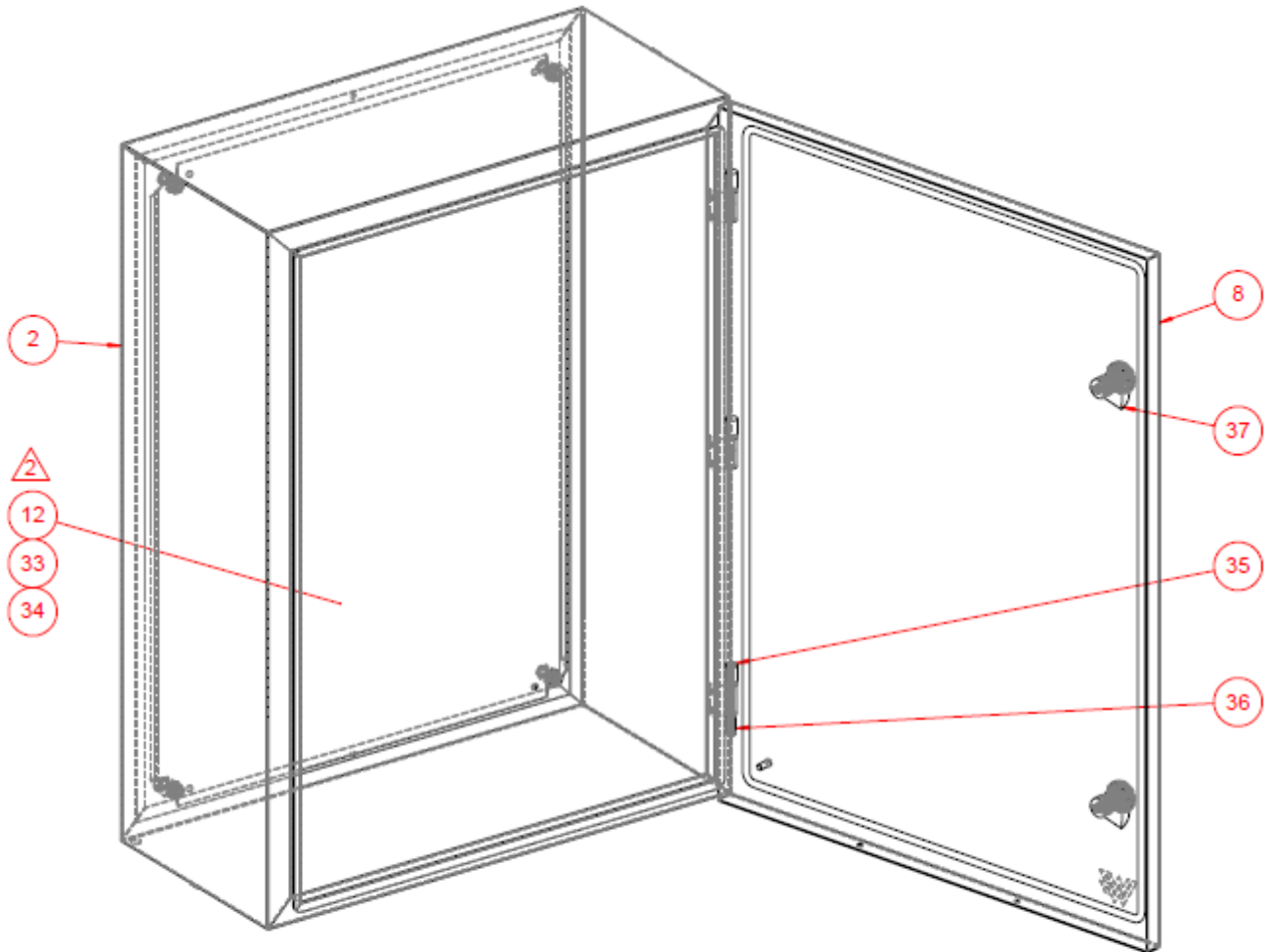

37	25.55.201.01	IP55 PANEL LOCK Ø25	2
36	100-23594	PIN RETAINER	1
35	100-24104S	HINGE PIN	1
34	M8	HEX NUT	4
33	M8	WASHER	4
12	210-10281 REV 7	PERANO 105 CHASSIS	1
8	202-5181 REV 1	W.A. PERANO 105 DOOR	1
2	202-5172 REV 3	W.A. PERANO 205 MAIN BODY	1
ITEM NO.	PART NUMBER	DESCRIPTION	QTY.

BRANCH CONTACT DETAILS

Johannesburg 010 202 3300
 Germiston 011 418 9600
 Cape Town 021 510 0710
 Pinetown 031 700 4215
 Riverhorse 031 492 4800

NATIONAL CALL CENTRE

Sales 010 202 3400
 Technical 010 202 3500

www.acdc.co.za