

MASTECH®

MS2205

DIGITAL CLAMP METER OPERATION MANUAL

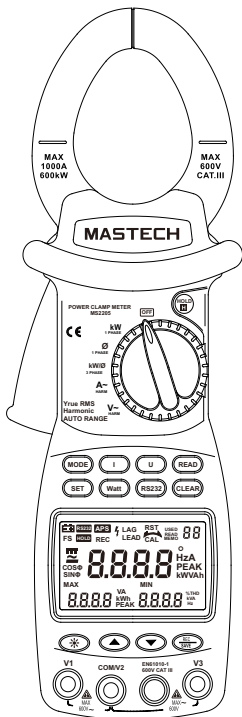

CAT III
600V

MASTECH®

CONTENTS

Safety Requirements.....	1
Safety Instructions.....	2
Safety Sign.....	2
General Description.....	2
Features.....	3
Appearance.....	4
Knob Switch Operations.....	6
Button Switch Operations	7
LCD Display.....	10
Instruction Manual	12
Test Data Storage	21
Read Saved Data.....	22
RS232C Data Interface.....	22
Input Voltage and Current.....	23
Backlight Display.....	23
Auto Power Off.....	23

MASTECH®

CONTENTS

Diagram of Safe Holding	24
Power curve diagram.....	25
Battery-low Indication.....	26
Battery Replacement.....	26
General specification.....	28
Technical specification	28
Accessories	29
Replacing Test Leads.....	31
Replacing The Batteries.....	31

Safety Requirements

Please carefully read the instruction manual before using the tester, and pay special attention to “Warning” content. Please follow instructions under “Warning”.

1. Please be very careful when test voltage is higher than AC 30 V, and do keep in mind that your finger shall not exceed the hand-shielding part of the test probe.
2. Do not measure voltage which is higher than the allowed input limit.
3. Before use, please check the meter and test probe; do not carry out testing in case the test probe is naked, tester housing is damaged, or there is no LCD display, etc..
4. It meets requirements of safety standards only when the meter is used together with the supplied test probes. In case the test probe is damaged and needs replacement, it is required to replace it with a test probe of the same model and identical electrical specifications.
5. Please never carry out any voltage measurement whenever the test probe is inserted in any current outlet.
6. Please do not expose the meter to strong light, high temperature, or dampness.





Warning

Before use, please carefully read this instruction manual. Especially safety contents!

Safety Instructions

The three-phase clamp-type digital power meter is designed and manufactured in accordance with international standard, IEC61010-1, and international safety specification, IEC1010-2-032, and the meter strictly follows the safety standard of double-insulation AC 600 V CAT III.

Safety Sign

	Important safety signs; please refer to instruction manual
	High voltage hazard
	Earthing
	Double insulation (Category-II safety equipment)
	Battery low Indicator

CAT III (MEASUREMENT CATEGORY III): It is applicable to test and measuring circuits connected to the distribution part of the building's low-voltage MAINS installation.

General Description

The 3-phase clamp-type digital power meter is a hand-held intelligent harmonic power tester, with both functions of digital current testing and power testing. The tester is comprised of three channels including voltage, current, and power as well as a micro single chip system, and it is equipped with a powerful software for measurement and data processing functions; it can measure, calculate, and display voltage, current, active power, power factor, apparent power, passive power, frequency, harmonic

parameters, with stable performance and operation convenience. The meter is especially suitable for the measurement and examination of on-site power equipment and power-supplying circuits; with hand-held clamp structure, small volume, and light weight, it can be easily carried by the user, which makes it easy and fast for doing measurement. For measurement of single-phase/three-phase power, The meter is your ideal choice

Features

1. The meter can be used for testing power, voltage, current, peak value, phase, frequency, power factor, phase angle, and reaction factor, etc. of single-/three-phase circuit; automatic phase sequence testing is possible for 3-phase measurement.
2. True effective value measurement: accurate measurement is possible even with serious distortion in current waveform.
3. Low-consumption high-speed single-chip microprocessor is employed and sophisticated algorithm is applied, as a result, results can be obtained rapidly and precisely, and up to 20 harmonics and distortion value thereof can be measured.
4. It is equipped with a large-size memory for saving up to 100 groups of test parameters.
5. It is equipped with RS232C communication and recording interface and dedicated WINDOWS graphics software.
6. Hand-held, clamp-type structure, with light weight, convenient for carry-on.

Appearance

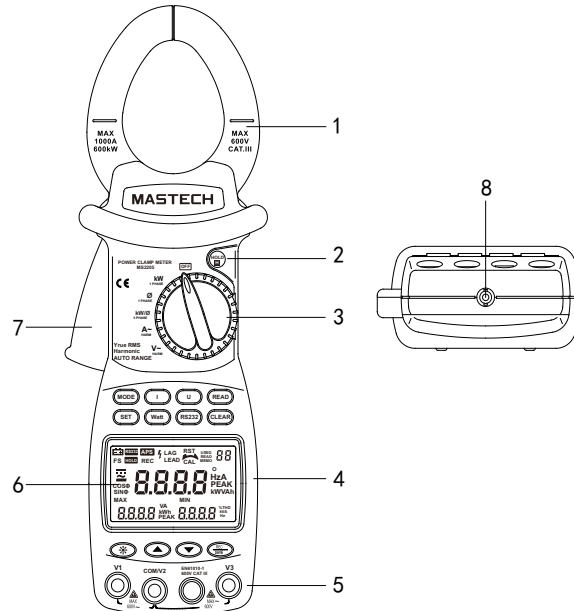

MASTECH®

1. Current clamp size: Φ 50 mm
2. HOLD button :DATA HOLD button; press down HOLD button, and the last reading will be held and displayed on the display, and "HOLD" symbol will be shown; press HOLD button again, and the meter will switch back to normal measurement mode.
3. Function-switching knob :Rotation knob for selecting different measuring function
4. Function-selection button: Button for operating the measuring functions
5. Input terminal

Terminal	Function
V1	Input terminal for measuring the first phase; use yellow test probe for connection.
COM/V2	Input terminal for measuring the 2nd phase; use black test probe for connection. Common terminal: ground input terminal (earthing) for all measuring functions; use black test probe for connection.
V3	Input terminal for measuring the 3rd phase; use green test probe for connection.

6. LCD display :4-digit digital display; 7-section LCD for displaying measurement operation function, test result, and unit sign.
7. Trigger :Press down the trigger, and the clamp will open; release it, and the clamp will close.
8. RS232C interface: Dedicated optical-electrical interface wire is used for online communication with

MASTECH®

PC, as well as for recording data and data trend curve in PC.

Knob Switch Operations

The function-switching knob is used for powering-on and for switching to any measurement function in the following table.



Sign	Knob position	Functions
OFF	Powering-off position	For powering-off
KW (1 phase)	Active power position	For measuring active power, etc.
Φ (1 phase)	Single-phase/phase-angle Test position	For measuring phase angle, such as $\cos \Phi$ and $\sin \Phi$, etc.
KW/ Φ (3 phase)	3-phase apparent power position	For measuring 3-phase apparent power, etc.
A~	AC-Current harmonics test position	For measuring AC-current harmonics, etc.
V~	AC-voltage harmonics test position	For measuring AC-Voltage harmonics, etc.

Note:

When the meter is automatically powered off, be sure to switch the knob to "OFF" position; turn on the meter after 5 seconds.

Button Switch Operations

Button descriptions

SN	Function-selection button
1	MODE :Test-mode switching button
2	SET : SET button
3	I :Current test button
4	WATT Power test switching button
5	U :Voltage test button
6	READ Data-Reading button
7	RS232 RS232C button
8	CLEAR Clear memory button
9	 Backlight button
10	 Reverse-search button
11	 Forward-search button
12	REC/SAVE Data recording & storage button
13	HOLD Hold button

The following functions can be realized through button operations:



WATT Button

Under test mode, you can measure active power, apparent power, power factor, and phase angle and display the results on LCD by pressing WATT button.

MODE Button

Under KW-test mode, you can press MODE button to switch the display of active power and passive power; under A/V~ test mode, you can switch the display among total harmonic distortion rate F, r, and harmonic percentage.

SET Button

Under test mode, you can press SET button and then press  and  button to set the range of current and voltage, and then press this button again to return. This button serves as CONFIRMATION button during storage and deleting.

U Button

Under test mode, you can press this button to test voltage of the present circuit, and display the measured voltage of the present circuit on display.

READ Button

Under HOLD mode, you can press this button to display the stored data; press this button again to return.

I Button

Under test mode, you can press I button to measure current of the present circuit and display the measured current of the circuit by the clamp on LCD.

RS232 Button

Under test mode, you can press RS232 button to transfer the present test result to PC through a dedicated interface wire supplied for the meter so as to record/print data and data trend graph.

MASTECH®

Before pressing RS232 button for data transferring, the supplied RS232C interface wire shall be connected to RS232C interface socket of the meter and PC COM port, before realizing communication functions.

CLEAR Button

Under data-reading mode, you can press CLEAR button and then press SET button to clear the test data which is stored in the meter under a specified number.

☼ Button

You can press ☼ button to turn on or off the backlight. After it is turned on for 20 seconds, the backlight will automatically be turned off.

▲ Button

Under VOLTAGE-RANGE-SETUP mode, you can press ▲ button to change the voltage test range. During testing harmonics, you can change the times of harmonics.

When reading the saved data, you can press ▲ button to search backward the stored data and show it on LCD. With every press of the button, the searching cursor will move one step backward to the previous data.

▼ Button

Under CURRENT-RANGE-SETUP mode, you can press ▲ button to change current test range. During testing harmonics, you can change the times of harmonics.

MASTECH®

When reading the saved data, you can press ▼ button to search in the forward direction the stored data and show it on LCD. With every press of the button, the searching cursor will move one step forward to the next data

REC/SAVE Button





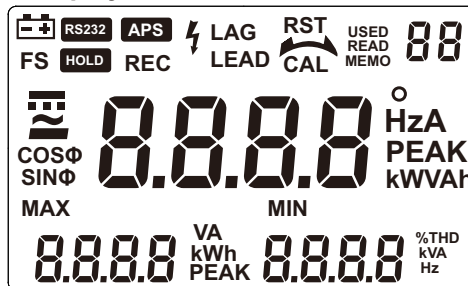

Under TEST mode, you can press REC/SAVE button to display the max. /min. power, current, voltage that is currently measured; under DATA HOLD mode, press this button to display the stored number; press SET button again to save the held data in the meter. Up to 100 groups of data can be stored in the meter.

HOLD Button

After measurement, press this button to hold this data on LCD; after powering-off, data will display.

LCD Display



LCD symbol	Description	LCD symbol	Description
RS232	Data transfer	REC	Data recording
APS	Auto powering-off	F	Fast
HOLD	Data holding	S	Slow
LAG	Phase angle lag	LEAD	Phase angle lead
	Battery power indication	O	Phase angle (degree)
SINΦ	Reversed power factor	COSΦ	Power factor
RST	3-phase		Normal phase
	AC symbol		Reversed phase
	Phase lacking		Negative symbol
MIN	Minimum value	MAX	Maximum value
USED	Used	MEMO	Save
READ	Read	V	Voltage
W	Watt	A	Current
VA_r	Passive power	Hz	Frequency

LCD symbol	Description	LCD symbol	Description
VA	Apparent power	PEAK	Peak value
%	Harmonic percentage		High-voltage warning sign
%THD	Total harmonics distortion ratio		
H01F	Total harmonics distortion ratio F (relative to base wave)		
H01r	Total harmonics distortion ratio r (relative to real effective value)		

Instruction Manual AC voltage (V) measurement

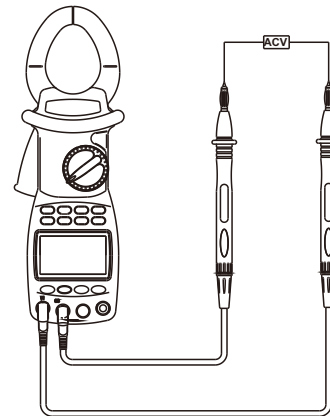

Switch	Inputting terminal V1	Inputting terminal V2	Inputting terminal V3	Test object
V~	V1 socket	COM/ V2 socket	N/A	1-phase
	V1 socket	COM/ V2 socket	N/A	2-phase
	V1 socket	COM/ V2 socket	V3 socket	3-phase

1. According to the connection mode as above Table , switch the function switching knob to V~, select corresponding sockets from V1, V2, or V3 terminal, and insert the test wire.
2. Connect the two test probes V1, V2 to the power source or load to be tested. The meter will automatically test and display the result, and the present harmonics percentage will be shown on the following line.
3. Under voltage test mode, press SET button to show "Auto V" and "Auto A" on LCD, and press ▲ to select a proper voltage range, and then press SET to return.
4. Press MODE button to show harmonics percentage on LCD, and the total harmonic distortion ratio F and R will be cyclically displayed. Press ▲/▼ button to display value of each measurement of the harmonic.
5. When input voltage is greater than 50 V, "⚡" sign will be shown on LCD, prompting you to pay attention to safety.

AC-current (A) measurement

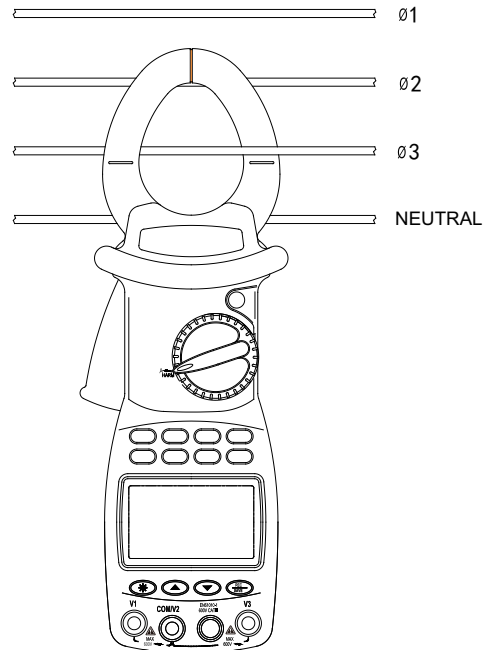

1. Switch the function knob to A~ position;
2. Pull the trigger to open the clamp, and then clip a wire which is to be tested; the measured current value will be automatically shown on LCD
3. Press MODE button to show harmonics percentage on LCD, and the total harmonic distortion ratio F and r will be cyclically displayed.
4. Press ▲/▼ button to display value of each measurement of the harmonic.
If current of the wire being tested is greater than 1000 A (RMS), "OL" symbol will be displayed instead of current value.

Note:

1. You can select 50/60-Hz FIXED/AUTO frequency test (AUTO). When input waveform fluctuates, displayed harmonic values can be kept stable if 50/60-Hz FIXED mode is selected.
2. Under AUTO frequency test mode, FFT calculation is performed only when base-wave frequency is between 45 and 65 Hz; harmonic analysis is not performed when base-wave frequency exceeds this range.

Test of single-phase circuit

1. Clip the clamp on the test wire of the power supply or load. If the user needs to measure a certain phase of the 3-phase circuit, then the clamp should clip on the wire of the same phase.
2. Switch the function switching knob to KW position, select corresponding input sockets from V1 or V2 terminal and insert the test wire.

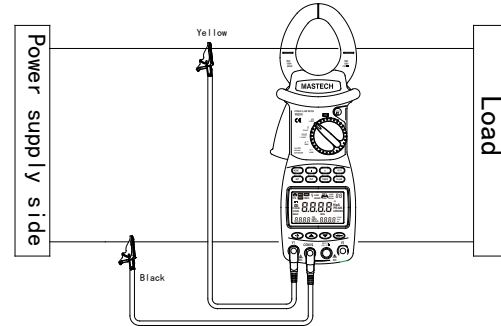

3. After it is correctly connected, you can measure single-phase power (active power, power factor, apparent power, passive power, voltage, current, phase angle, peak value of voltage and current, and frequency):
4. The meter will carry out automatic measurement and display active power, and voltage/current value of the load being tested will be displayed on the bottom line of LCD; press down MODE button, Var value of passive power will be displayed on LCD; press WATT button to display apparent power and power factor (cos Φ); negative power factor signifies that the load being tested is a load with capacitor characteristics.
5. The maximum measurement range of active power kW is 600 kW; if this range is exceeded, "OL" symbol will be displayed beyond this range. If voltage being tested is greater than 600 V, or current being tested greater than 1000 A, "OL" symbol will be displayed on LCD.

- The min. input voltage is 50 V and the min. input current is 2A; if active power value is smaller than this limit, "0.00 kW" will be displayed in stead of active power value.
- Press SET button to display AUTO, and press ▲/▼ button to set measurement range for voltage and current; press SET button to return.
- Press down I button, current value, current peak value and frequency will be displayed on bottom line of LCD.
- Press down U button, voltage value, voltage peak value and frequency will be displayed on bottom line of LCD.
- Press REC/SAVE button to show MAX and MIN
- Passive power is a value not directly measured; equation for kVA_r is $kVA_r = kVA^2 - kW^2$; its value is calculated by software based on the measured voltage, current and active power, and displayed on LCD.

cosΦ, sinΦ, and phase angle measurement

- Switch the function-switch knob to Φ (1 phase) position, and the test wire is inserted to V1/V2 input terminals.
- The meter will automatically measure and display power factor, voltage value and current value.
- Press WATT button to display phase angle, power factor (cos Φ), and sinΦ; negative power factor signifies that the load being tested is a load with capacitor characteristics.
- Press down I button, current value, current peak value and frequency will be displayed on bottom line of LCD.

- Press down U button, voltage value, voltage peak value and frequency will be displayed on bottom line of LCD.
- Press REC/SAVE button to show MAX and MIN
- Press SET button to display AUTO, and press ▼/▲ button to set measurement range for voltage and current; press SET button to return.
- After measuring, press HOLD button to keep showing the data on LCD, and press REC/SAVE button to display the saved serial number, and then press SET button to confirm it and return.

Single-phase three-line circuit

the process for measuring power and power factor for single-phase three-line circuit is the same as that for single-phase two-line circuit, where the black clip is connected to the middle wire, and the red clip and clamp-type sensor are simultaneously connected to all test wires.

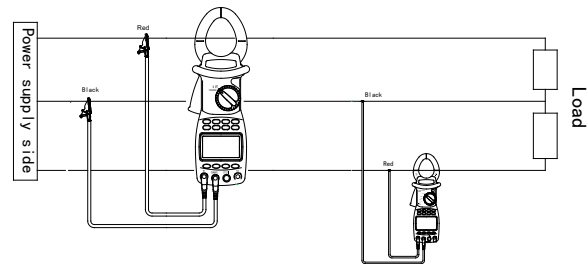

Measuring power of 3-phase load (for balanced load)

1. In the case of balanced load, process for measuring power and power factor of 3-phase 4-line circuit is the same as that for 3-phase 3-line circuit, and it is not needed to use the middle line.
2. 3-phase total power parameters are referred to as total active power, total passive power, total apparent power, and total power factor of 3-phase circuit. The meter cannot carry out 3-phase energy measurement. In the case of balanced load, measured result is accurate, while error of total power will increase if power variation is large.
3. switch function-switching knob to kW/ Φ (3 phase) position, and connect test clamp to phase-1 test wire of the load, and then connect V1 terminal / yellow test probe, V2 terminal / black test probe, and V3 terminal / green test probe to the live line of phase 1, phase 2, and phase 3, respectively, of the 3-phase load without connecting the neutral line.
4. After the test lines are properly connected, the meter will automatically perform measurement and display power, voltage, current, and whether a phase is missing.
5. Press MODE button to display Var value of passive power on LCD.
6. Press WATT button to display apparent power, power factor ($\cos \Phi$), phase angle, and $\sin \Phi$; negative power factor signifies that the load being tested is of capacitor characteristics.
7. Press down I button, and current value, current peak value and frequency will be displayed on LCD.

8. Press down U button, and voltage value, voltage peak value and frequency will be displayed on LCD.
9. Press SET button to display AUTO, and press $\blacktriangle/\blacktriangledown$ button to set the measuring range for voltage and current, and then press SET button to return.
10. After measuring, press HOLD button to keep showing the data on LCD, and press RES/SAVE button to display the saved serial number, and then press SET button to confirm it and return.

Phase sequence test

1. the meter will automatically test the phase sequence.
2. The display of \overline{RST} signifies normal phase sequence.
3. The display of \overleftarrow{RST} signifies reversed phase sequence.
4. The display of \overline{RST} signifies missing phase.
5. During measurement, press REC/SAVE button to show MAX and MIN and record the results. Then, press REC/SAVE button to transfer the test result to PC through infrared communication wire.

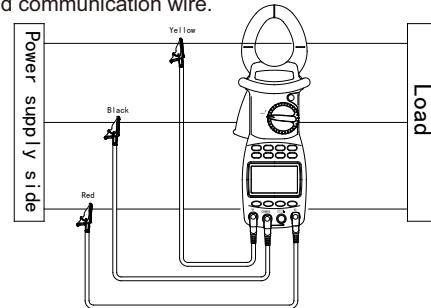

Measurement of power and power factor of 3phase 3-line circuit

Measuring power of 3-phase 4-line load (for imbalanced load)

In the case of imbalanced load, the measuring process is the same as that of 1-phase 2-line system, and the measuring mode is set as 1-phase mode. connect the black clip to the middle line, and then simultaneously switch the yellow clip and clamp sensor to corresponding wires; under this mode, power and power factor of each line can be tested. (To test phase sequence, connect voltage clips to the three lines one by one, with the middle line not connected)

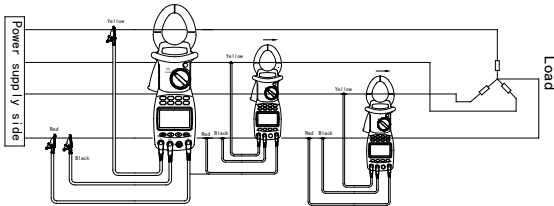

Measurement of power and power factor of 3-phase 4-line circuit

Test Data Storage

When the meter is under HOLD mode, you can press REC/SAVE button to display the serial number to be saved and press ▲/▼ button to select serial number, and then press SET button to confirm saving. Test results are saved in the meter, and up to 100 groups of data can be saved in the meter.

Before pressing SET button, if you press REC/SAVE button to quit saving, data will not be saved, and it will return to the previous menu.

Read Saved Data

1. When any data is saved in the meter, you can switch it to READ SAVED DATA position for data retrieving.
2. Switch function-switching knob to SEARCH position and press HOLD button to display HOLD.
3. Press READ button to show the saved serial number and data on LCD.
4. If you need to check the records stored previously or afterwards or harmonic level, press ▲/▼ button to make selections.
5. When harmonic level data is displayed, press watt button, then press ▲/▼ button to select record number.
6. To delete data, just press CLEAR button, and CLR will be displayed; then, press SET button to confirm it, and data will be deleted. Before pressing SET button, if you press CLEAR button, data will not be deleted, and it will return to the previous menu.

RS232C Data Interface

1. Insert RS232C interface wire into the socket on the meter, and rotate interface wire clock-wise to lock the wire in the power meter; connect the standard RS232C plug on the other end of the interface wire to PC COM port, and now real-time data transferring with PC can be realized through the infrared communication RS232C interface. If you wish to unplug the RS232C interface wire from the power meter, firstly, rotate the interface-wire plug in the meter counter-clockwise, then, take it out after the interface wire is unlocked.
2. If you press RS232 button, the currently measured data can be recorded in real time under WINDOWS;
3. If you press HOLD button, and then READ button, and then RS232 button, the saved data can be uploaded

to PC.

4. This software can be used for managing real-time data records, plotting, and printing output, etc..

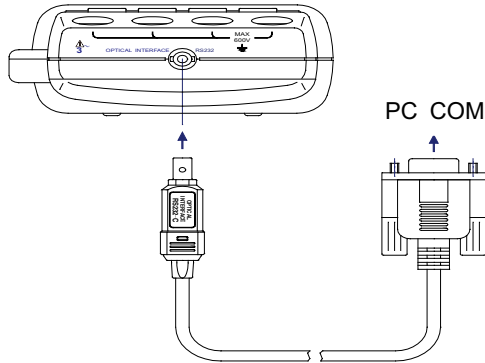

(RS232C connection diagram)

Input Voltage and Current

During power measurement, if input voltage is over 600 V (RMS) or current over 1000 A (RMS), "OL" symbol will be displayed and bar symbol shown in full scale. When input voltage is over 50 V, "⚡" sign will be shown on LCD, prompting you to pay attention to safety.

Backlight Display

Press , the backlight will be lit up, and it will then be automatically turned off after about 20 seconds.

Auto Power Off

1. If there is no function change or button press for 10 minutes, the meter will automatically turn power off. When the meter is automatically powered off, be sure to switch the knob to "OFF" position; turn on the meter after 5 seconds.
2. Holding the button SET & CLEAR down while turning the meter on, disables automatic power-off.
3. Automatically powered off function will be disabled while the meter is in MAX/MIN Record mode and the meter performing communication with PC software.

Diagram of Safe Holding

Using a wrist belt can prevent unintended dropping of the meter.

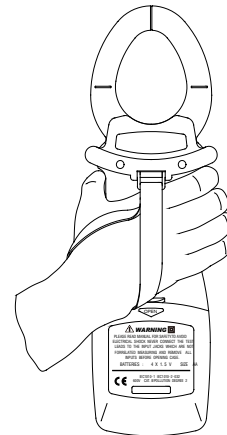

Power curve diagram

(Active power = apparent power × PF)
 using wrist belt can prevent unintended dropping of the meter.

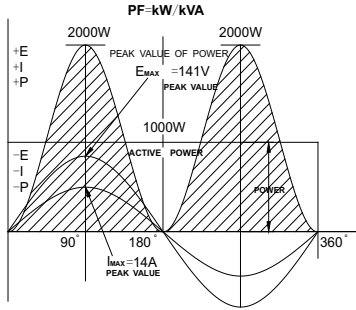

PF=1

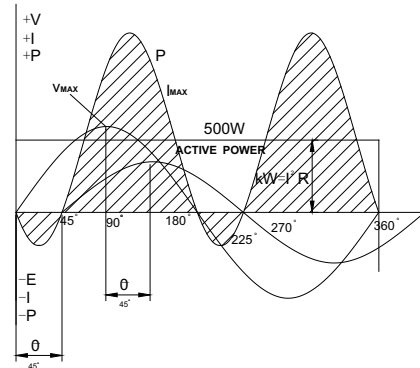
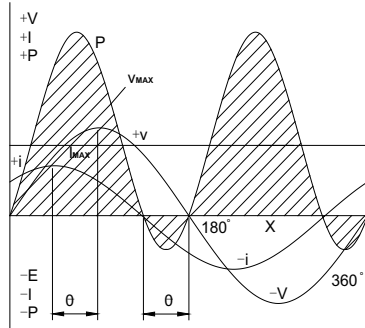

Battery-low Indication

If battery voltage is low, "⚡" symbol will be displayed on the upper right corner of LCD. Then, it is needed to replace new batteries.

Battery Replacement

Warning

1. Before opening the back lid to replace batteries, please make sure the meter is turned off and no test probe is connected to any test wire so as to avoid electrical shock; before using the meter, please make sure the back lid is tightly closed. Only batteries of identical model or electrical specification can be used.
2. If "⚡" symbol is shown on LCD, it signifies that battery voltage with load is lower than the minimum voltage for ensuring measurement error limits, and the meter will prompt you to change new batteries. Please follow the steps below to replace batteries:

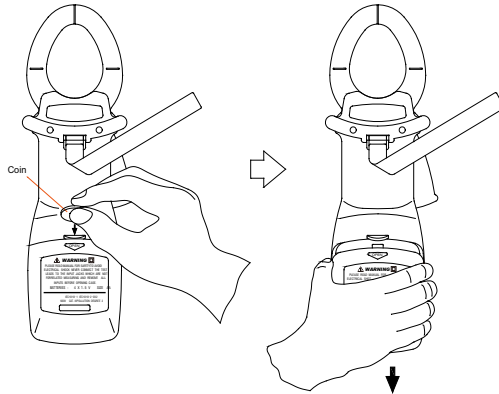

3. Disconnect test probes from test circuit, and rotate function-switching knob to "OFF", and then take off test probes from the input sockets.
4. Open battery cover, and pay attention to the self-locking structure of the cover; you can open the cover as per Figure 23: insert a coin to the slot on the cover, and press down the coin to open the lock buckle, and then slide off the cover downward. Please do not use tapered tool to pry open the cover, otherwise meter housing will be damaged.
5. Take out old batteries, and replace them with 4 new 1.5 V batteries. New batteries shall not be used together with old ones.
6. Properly close the battery cover.

General specification

Complies with IEC/EN 61010-1 1000V CAT II ,600 V CAT III

1. Max. common-mode voltage: 600V AC RMS
2. Mode of display: LCD display; Max. reading: 6000
3. Range selection: Fully automatic range selection
4. Frequency detection: automatic (when harmonic is serious, it is better to use manual settings for testing frequency so as to assure the reading stability)
5. Over-range display: "OL"
6. Data holding: "HOLD" is shown on LCD
7. Power supply: 4 batteries of 1.5 V, AA
8. Power consumption: 250 mW
9. Storage temperature: - 20 °C ~ 70 °C
10. Operating temperature: 0 °C ~ 40 °C
11. Temperature Coefficient: 0.05×(specified accuracy) per °C
12. Electromagnetic Compatibility: In an RF field of 3V/M, accuracy=specified accuracy , Otherwise accuracy is unspecified.
13. Operating Altitude: 2000m CAT III 600V;3000m CAT II 600V
14. Store Altitude: 12000m
15. Dimensions: 300mm×103mm×51mm
16. Weight: about 500 g (with battery)

Technical specification

Accuracy: \pm (% read + graduation #) ambient temperature: 18°C ~ 28°C, Humidity 80%, frequency for voltage, current: 45 Hz ~ 65 Hz

MASTECH®

AC voltage RMS

Range	Accuracy	Resolution	Input impedance
80V	± (1.0%+5)	0.1V	1 MΩ // 10 pF
180V	± (1.0%+5)	0.1V	
400V	± (1.0%+5)	1V	
600V	± (1.0%+5)	1V	

Max. allowed overload voltage: 750 V (RMS)

AC Current RMS

Range	Accuracy	Resolution
20A	± (2%+5)	0.01A
40A	± (2%+5)	0.01A
100A	± (2%+5)	0.1A
200A	± (2%+5)	0.1A
450A	± (2%+5)	1A
1000A	± (2%+5)	1A

Max. allowed overload current: 1200 A

Single-phase active power (W)

Range	Accuracy	Resolution
30kW	± (3%+5)	0.01kW
60kW	± (3%+5)	0.01kW
120kW	± (3%+5)	0.1kW
150kW	± (3%+5)	0.1kW
300kW	± (3%+5)	0.1kW
600kW	± (3%+5)	0.1kW

Min. test current: 2A; Min. test voltage: 50V

MASTECH®

Three-phase active power (W)

Range	Accuracy	Resolution
3kVA	± (3%+5)	0.001kVA
12kVA	± (3%+5)	0.01kW
30kVA	± (3%+5)	0.01kVA
120kVA	± (3%+5)	0.1kVA
150kVA	± (3%+5)	0.1kVA
600kVA	± (3%+5)	0.1kVA

Min. test current: 2A; Min. test voltage: 50V

Power factor

Range	Accuracy	Resolution
0.3~1 Capacitive	± (0.02+2)	0.001
0.3~1 Inductive	± (0.02+2)	0.001

Min. test current: 2A; Min. test voltage: 50V

Passive power

Range	Accuracy	Resolution
3kVAr	± (3%+5)	0.001kVAr
12kVAr	± (3%+5)	0.01kVAr
30kVAr	± (3%+5)	0.01kVAr
120kVAr	± (3%+5)	0.1kVAr
150kVAr	± (3%+5)	0.1kVAr
600kVAr	± (3%+5)	0.1kVAr

Min. input current: 2A; Min. input voltage: 50V

Passive power Var is calculated according to the measured V, A, and kW value.

MASTECH®

Frequency

Range	Accuracy	Resolution
30Hz~1000Hz	0.5% + 1 graduation	0.1Hz

Min. test voltage: 50 V

Harmonic test

Harmonic number	Precision of harmonic voltage
1	$\pm (3.0\%+10)$
2-6	$\pm (3.5\%+10)$
7-8	$\pm (4.5\%+10)$
9-10	$\pm (5.0\%+10)$
11-15	$\pm (7\%+10)$
16-20	$\pm (10\%+10)$

Min. test voltage 50V;Min test current 2A

Accessories

Item	Quantity
Instruction Manual	×1
1.5VAA Battery	×4
Test probe	×1
Test clip	×3
Interface cable	×1
PC Software CD	×1
Package box	×1

Quality Assurance

MASTECH®

Thank you for using the product of our company; this product has a warranty period of one year starting from purchasing date.

This product has passed the strict quality test of our company. Our company will exert our efforts to do after-sales service for you in accordance with the

Warranty instructions.

In case there is any problem occurred during warranty period, which is resulted from product quality problem, please fill in the warranty card and mail it in together with the product, and the service department of our company will repair it or replace it free of charge, while the user himself/herself shall not take the meter apart. When warranty period is over, the repairing will be charged

Free service does not apply to the following cases:

Problems and damages due to improper use or use under environment which is not stipulated for this product, including overloading.

Problems and damages due to unauthorized dismantling or refitting and misuse.

Problems and damages due to user reasons.

Problems and damages due to natural disasters.

Replacing Test Leads

Replace test leads if leads become damaged or worn.

 **WARNING**

Use meet EN 61010-031 standard, rated CAT III 600V, or better test leads.

Replacing The Batteries

 **WARNING**

To avoid electric shock, make sure that the test leads have been clearly move away from the circuit under measurement before opening the battery cover of the meter.

 **WARNING**

Do not mix old and new batteries. Do not mix alkaline, standard (carbon-zinc), or rechargeable (ni-cad, ni-mh, etc) batteries.

- 5.1.1 If the sign “” appears, it means that the batteries should be replaced.
- 5.1.2 Loosen the fixing screw of the battery cover and remove it.
- 5.1.3 Replace the exhausted batteries with new ones.
- 5.1.4 Put the battery cover back and fix it again to its origin form.

Note:

Do not reverse the polarity of the batteries.

