

# POWER FACTOR CONTROLLER RG-B/BS



This user manual is prepared for quick commissioning and operating of the device. Please read this manual carefully before commissioning or operating RG-B/BS

## Precautions for Safe Use and Installation

- Maintenance, installation and operation of RG-B/BS must be performed only by the qualified technicians.
- RG-B/BS is connected to the network with current transformer. Do not disconnect the current transformer terminals. If you disconnect them, be sure to short-circuit or connect them to another parallel load which have low impedance. In case of failure, dangerously high voltage at the secondary side of current transformer may cause an electric shock.
- Device is suitable only for panel mounting.
- Verify terminal connections when wiring.
- Do not use this product for any other purpose than its original task.
- Do not operate undervoltage.
- When device is connected to the network, do not remove the front panel.
- Do not open the RG-B/BS's housing. There are no user servicable parts inside it.
- Do not clean the device with solvent or similar items. Only clean with a dry cloth.
- Electrical equipment should be serviced only by your competent seller.



No responsibility is assured by the manufacturer or any of its subsidiaries for any consequences arising out of the use of this material.

## DIMENSIONS

- Panel cut-out dimension must be 91 mm x 91 mm for Type PR19 and 143 mm x 143 mm for Type PR16.
- Before installation, remove the mounting brackets.
- Mount the device to front panel.
- Insert the mounting brackets.
- Wire thickness for voltage and current terminals must be 2,5 mm<sup>2</sup>, but it is suitable for cables which have up to 4 mm<sup>2</sup> section.
- CAT5 cable is recommended for RS-485 input terminal.

**Excessive force can damage to the device.**

**Turn the screw into the terminals and tighten until the RG-B/BS is secured in place.**

## CONNECTION DIAGRAM

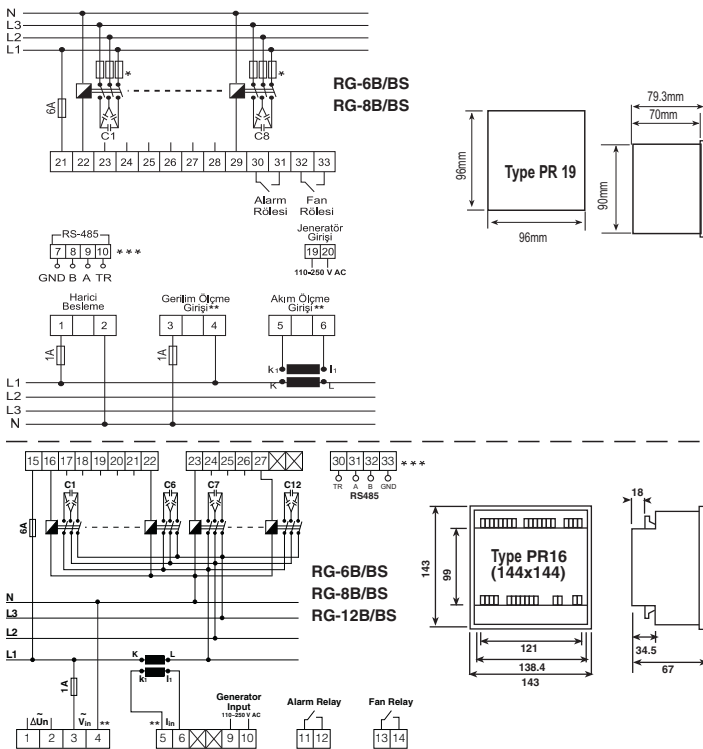

\* Current value of 3-Fuses, which are connected to protect the capacitors, is chosen according to the nominal current value of capacitors.

\*\* At 3 phase 4 wire applications L1 and Neutral must be connected device's voltage measurement inputs, at 3 phase 3 wire applications L2 and L3 phases must be connected. L1 phase's current transformer must be connected to current measurement input. If load is unbalanced, current cable which is nearest value of total average value must be connected to current transformer. In this condition voltage inputs must be set refer to current. When device programmed to automatic setup, it will program suitable phase angle. So it will measure true values and true compensation.



Do not use device without checking terminal connections.

## 1. RG-B/BS Connection

- For proper operation, current and voltage connections must be connected as shown in the connection diagram.
- After current and voltage terminal connections, capacitor steps' connection must be done according to the connection diagram.
- Lastly, computer communication connection must be done.
- Do not power-up the device before verifying terminal connections.

## 2. Commissioning RG-B/BS

- Device can detect wrong connection on the way of active power. For correcting connection fault, automatic setup must be mode or in transformer menu there is a sub-menu named "AngL", which is programming phasor angle, suitable phase value must be programmed from here. When user do automatic setup (ASeT), device will open and close 3 phase capacitor in 1st step during correction of connection failure. Sudden changes in loads and nonlinear loads (Thyristor or triac controlled frequency inverter, UPS etc.) existing, automatic setup may not be done. In this condition, user should disconnect the device and restart it and make the same operation. This operation can do with selecting "S-on" under "ASeT" menu. In this case device corrects the errors and then calculates the capacitor values. If user does not want calculating capacitor values, selecting "S-oF" parameter provides this.
- User must enter capacitor values after entering current and voltage transformer ratios. Capacitor values can be calculated automatically or manually. Device's "ASeT" selecting "S-on" (for details please look Operating Mode Settings) capacitor values will be entered automatically. If 10<sup>th</sup> program (PS-10) is selected in program menu all capacitor values are measured by switching on/off of the capacitors in sequence. In this program 3 phases capacitor can be connected, without any connection rule, for network needing. If user did this application just like at previous step, does not have to do this step. Selecting other program condition device only calculate 1st step and other steps will be calculated according to selecting program. Device calculates the capacitor values which will be switched "ON" according to selected program; so device switches "ON" / "OFF" the required steps.
- Connection of circuit breaker or automatic fuse between the network and RG-B/BS is highly recommended. Circuit breaker must be in close proximity to the device.
- All used fuses must be FF type and the current values of the fuses must be 2A or 3A and 6A (Refer to Connection Diagram).
- Generator input must be done only when the network is supplied by the generator. Otherwise device will be switched to the generator position for each generator starts including the maintaining purpose.

### Generator Input

When 110-250 V AC connection is connected to device's generator input "COS1" position will be at passive, "COS2" will be at active position. So, compensation will do on target COS2 during voltage cut at this input.

## CONTROLS and OPERATIONS



### Automatic Capacitor Recognition and Phase Setup Mode

Capacitor values are recognized and saved with "ASeT" operation. For doing this, enter program menu at device and find "ASeT" menu. "ASeT" menu includes 2 parameters which are "S-oF" and "S-on". When selection "S-on" and pressing SET button; firstly device try to find connection failures (such as wrong connection at voltage and current inputs) then recognize all capacitor's steps. If 10<sup>th</sup> program (PS-10) is selected, all capacitor's power will be measured. In other programs, only first capacitor step power is measured and other capacitor steps are calculated and recorded according to selected program. During capacitor recognition, "S-oF" is selected and pressing SET button, automatic recognition will be ended.

**Note: After this process, calculated power values of all capacitor steps always must be controlled. In order to have correct power values for capacitor steps, current and voltage transformer ratios must be entered correctly. If current and voltage transformer ratios are not entered, these ratios are supposed to be "1" and capacitor powers are calculated according to these values. (Refer to VT and CT ratio settings).**

**Note: If automatic setup is selected as "S-on", automatic mode starts immediately without waiting to escape from the menu.**

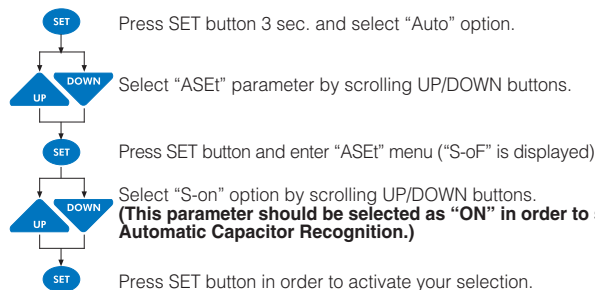

### Operating Mode (Automatic/Manual Mode) Settings

RG-B/BS has two operating modes which are automatic mode and manual mode. Operating mode can be selected by selecting "A-on" (automatic) or "A-oF" (manual) option. Manual mode is used for test purpose. In this mode, capacitor steps are switched on&off and so relay outputs of the device are tested. In the manual mode, capacitor steps are switched on by pressing "SEt" button and also capacitor steps are switched off by pressing "ESc" button. Factory set values for switching on (ond) and switching off (oFd) time is 10 sec. These time values can be programmed in the Delay (dELy) menu (Refer to delay time setting). In the manual mode, step numbers, which will be switched on&off, can be programmed in "StEp" menu (Refer to step number setting). Even if manual mode is selected, after 5 minutes, device starts to work in automatic mode and continues to operate in automatic mode.

When automatic mode is selected, AUTO/MAN LED lights on continuously. When manual mode is selected, AUTO/MAN LED blinks.

**Warning: Device warns user by blinking (short ON, long OFF) the capacitor steps which will be switched on. Also device warns user by blinking (long ON, short OFF) the capacitor steps which will be switched off. For switching capacitors; voltage inputs must be connected and measured voltage must be higher than (min. 0.5 multiple) programmed nominal network voltage.**

# POWER FACTOR CONTROLLER RG-B/BS

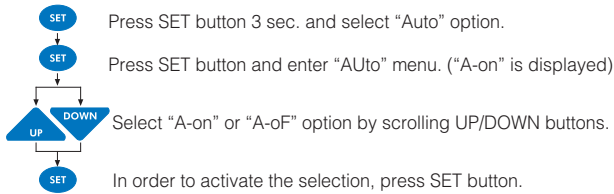

## trF CURRENT and VOLTAGE TRANSFORMER RATIO SETTINGS, PHASE ANGLE and VOLTAGE PROGRAMMING

In order to have correct power values for capacitor steps, current and voltage transformer ratios must be entered correctly. Current and voltage transformer ratios are entered in "trF" menu. If no value is entered in the menu, these ratios are supposed to be "1" and capacitor powers are calculated according to these values.

### Ctr Current Transformer Ratio

CT ratio can be programmed between 1 and 2000. This value must be the Current Transformer's ratio.  
Exp: For 150 A/5 A current transformer, CT ratio must be entered as "30".

### Utr Voltage Transformer Ratio

VT ratio can be set between 1-2000. This value must be the Voltage Transformer's ratio.  
Exp: For 34,5 KV / 100 V voltage transformer, VT ratio must be entered as "345".

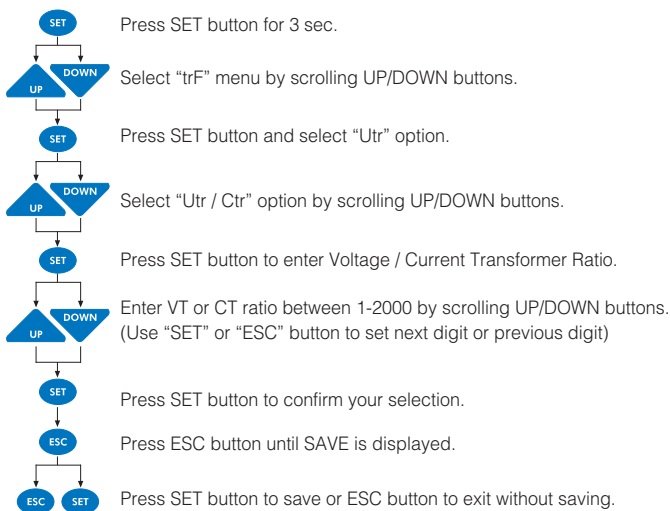

### An9L Phase Angle Setting

Changing phase angle for all possibility of current and voltage connections. If user knows phases, which are connected to measurement inputs, can be set at this menu as a manual. Automatic setup (ASET) is recommended for this application. End of "ASET" application, present connection displayed at this menu.  
-It can be programmed 30 degree differences between 0 to 360 (0, 30, ..., 330).

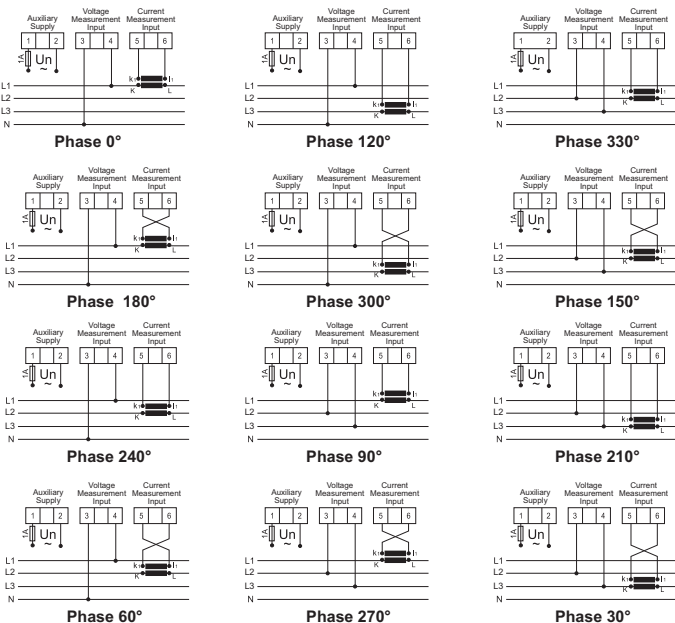

### U-no Operating Voltage Programming

Nominal voltage programming at the network. For making true compensation measured voltage value must be higher than min. 0.5 multiple of programming nominal network voltage.

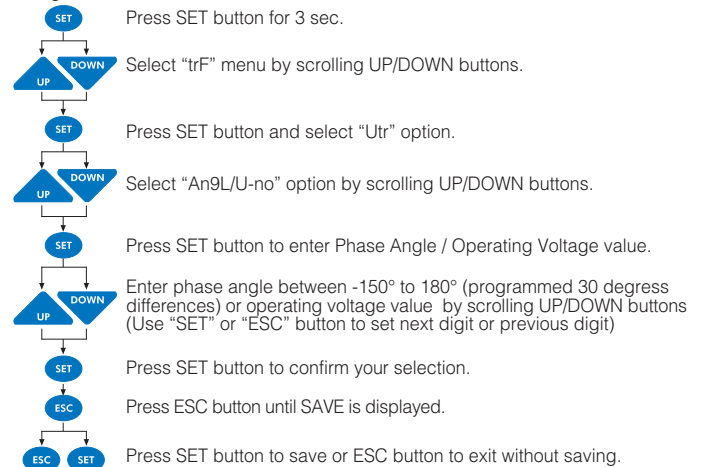

### Prog Program Selection

RG-B/BS has 10 different program modes which determines the power ratio sequences of capacitor steps. These are given at below. If capacitors sequence is set just like 2nd program (P-02) (1.1.1.1.....), all needs same connection components. Selecting between 3th program (P-03) to 8th program (P-08) capacitors need less connection components (exp: 1.2.2.....). 9th program (P-09) provides different group powers. 9th program's capacitor sequence working principle is one group's power can be higher than previous groups' first power sums. With this method less capacitors can be used. At 10th program (P-10), there is no rule of arranging the steps from low to high. With auto setup capacitor steps can be calculated automatically or user can enter the capacitor values manually. User can select steady or not used capacitor steps from CAP menu at 10th program. RG-B/BS counts the number of switch on/off of every steps and every time switches on required steps. With this method it saves capacitor's life time duration. Enter your required program such as below definition.

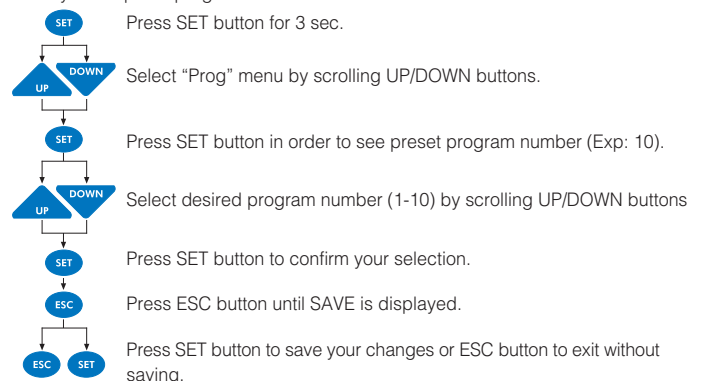

### Available Programs

PROGRAM	SEQUENCE
01	linear
02	1.1.1.1.....
03	1.1.2.2.....
04	1.2.2.2.....
05	1.2.3.3.....
06	1.2.4.4.....
07	1.1.2.4.....
08	1.2.3.4.....
09	1.2.4.8.....
*10	Any sequence can be selected by user.

\* Recommended program mode.

### CAP Step Number Setting

RG-B/BS has 8 capacitor steps. They can be programmed "oFF", "on" and "AUto" for each steps at 10th program.

AUto : Programming capacitor power (kVar) menu.

on : Capacitor programmed as a steady.

oFF : Meaning of there is no capacitor connection at output.

When other programs are selected, 1st step's capacitor power can be programmed. Other steps' power can be programmed according to selected program.

# POWER FACTOR CONTROLLER RG-B/BS

## dELY

### Delay Time Setting

Switching "ON" (ond), Switching "OFF" (oFd) and discharge time (rC) is programmed for the steps.

Delay time between 2 and 1800 sec. can be set in this menu.

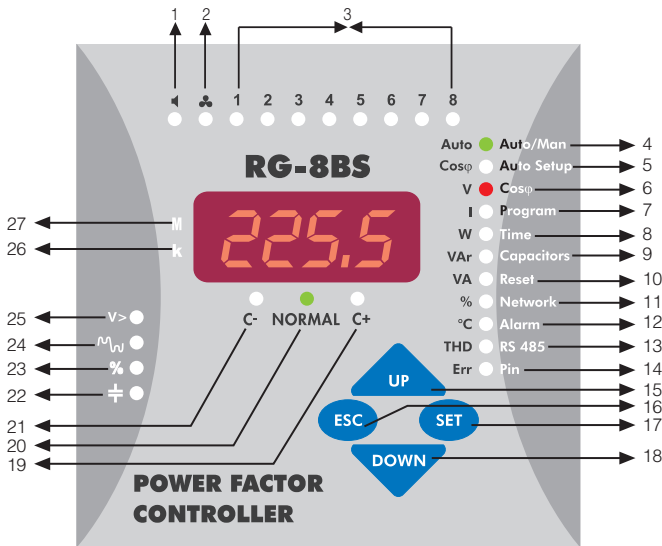
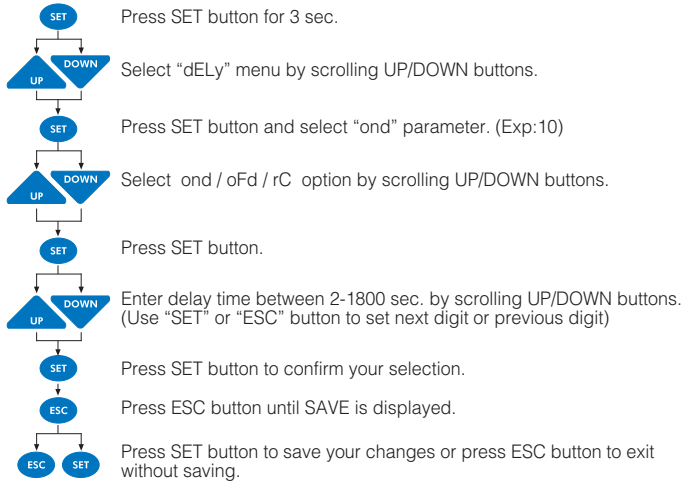

1. : In case of any failure, alarm relay is switched on and alarm led lights.
2. : When measured temperature value increase fan measured value after 10 second fan led light will be on.
3. 1,2,...,8 LEDs : Shows the status of each capacitor steps.
4. OTO/MAN LED : Indicates if the operating mode is automatic or manual. (If it is continuously ON, RG-B/BS operates in Automatic Mode. If it blinks, RG-B/BS operates in Manual Mode)
5. Cosφ /Auto Setup LED : Press SET button for 3 seconds, when Cosφ/Auto Setup LED is open, automatic setup is done. In measurement mode Cosφ value is displayed.
6. V / Cosφ LED : Press SET button for 3 seconds, when V / Cosφ LED is open COS1 and COS2 is programmed. In measurement mode voltage value is displayed.
7. I / Program LED : Press SET button for 3 seconds, select PROGRAM/I light to select power sequence program. In the measurement mode, current values of related phases are displayed.
8. W / Time LED : Press SET button for 3 seconds, select TIME/W led to set switching on delay time, switching off delay time and discharge time. In the measurement mode, active power value is displayed.
9. VAR / Capacitor LED : Press SET button for 3 seconds, select CAPACITORS/VAR led to set capacitor values and capacitor connections (Auto, on, off). In the measurement mode, reactive power values are displayed.
10. VA / Reset LED : Press SET button for 3 seconds, select RESET/VA LED for erasing alarms. In measurement mode apparent power value is displayed.
11. % / Network LED : Press SET button for 3 seconds, select NETWORK/% LED to set current transformer ratio (Ctr), Voltage transformer ratio (Vtr), phase angle (AngL) and capacitor nominal voltage value (U-no) is set. In measurement mode inductive and capacitive ratio values are displayed as %.
12. °C / Alarm LED : Press SET button for 3 seconds, select ALARM / °C LED to set alarms for over voltage, reactive/active ratio, temperature and harmonics. In measurement mode temperature is displayed.

### Technical Features

Operating Voltage (Un)	: (0.9-1.1)xUn	<b>Please look at the rear label of the device</b>
Operating Voltage Ratio ΔU	: 50mA-5.5A	
Operating Current Range ΔI	: 50 Hz / 60 Hz	
Frequency	: 1% ± 1digit (V,I,Cosφ),	
Measurement Class	: 2%±1 digit (W, VAR, VA)	
Power Consumption	: <2 VA(Current)	
Output Contact	: 3 VA - 10 VA (Voltage)	
Generator Input	: 5 A, 250 V AC, 1250 VA	
No-Volt Feature	: 110V AC ~ 250 V AC	
	: In case of power failure longer than 20 msec., all capacitor steps are disconnected automatically.	
Setting Range		
COS1 Setting	: -0,800, 0,800	
COS2 Setting	: -0,800, 0,800	
CT Ratio	: 1 - 2000	
VT Ratio	: 1 - 2000	
Switching on&off and, Discharge Time Setting	: Switching on&off and discharge times can be set between 2-1800 sec.	
Step Number	: 8	
Over Voltage Value	: Selectable.	
Ambient Temp. Range	: -5° C - 55° C	
Measurement Temp. Range	: 00.0 - 100 °C	
Display	: Red LED Display with 4 Digits	
Equipment Protection Class	: Double Insulation (  )	
Cable Section (for terminals)	: 2.5 mm <sup>2</sup>	
Terminal Protection Class	: IP 00	
Box Protection Class	: IP 40 (front panel)	
Connection Type	: Terminal	
Dimension	: Type PR19	
Panel Cut-out	: 91x91 mm	
Weight	: 0.70 kg.	
RS-485 Communication*		
Address	: 1-247	
Baud Rate	: 1,200 Kbps, 2,400 Kbps, 4,800 Kbps, 9,600 Kbps, 19,200 Kbps, 38,400 Kbps	
Parity	: no, odd, even	
<b>Default Factory Settings</b>		
Target COS1	: 1,000	
Target COS2	: 0,900	
Program	: P-10	
t-on (Switching on delay)	: 10 sec.	
t-off (Switching off delay)	: 10 sec.	
Discharge time	: 14 sec.	
Over Voltage	: 265,0 V AC	
Delay	: 3,0 sec.	
Step Protection	: oF	
Over Harmonic	: 5,0%	
Delay	: 3,0 sec.	
Step Protection	: oF	
Inductive Ratio Range	: 25	
Capacitive Ratio Range	: 15	
Ratio Time	: 240 hour	
Temperature Protection		
Alarm Value	: 55 °C	
Step Protection	: oF	
Lower Alarm	: 53 °C	
Fan Setting		
Operation Temperature	: 45 °C	
Lower Temp. Value	: 40 °C	
CT Ratio	: 1	
VT Ratio	: 1	
RS-485 Communication		
Address	: 1	
Baud Rate	: 9,600 Kbps	
Parity	: no	
Password	: 1234	
Password Activation	: oFF	

13. THD / RS-485 LED : Press SET button 3 seconds, select RS-485/THD LED for setting address, baudrate and parity values for RS-485 communication protocol. In measurement mode THD values (19th harmonics) is displayed by pressing SET button.
14. Err / Pin LED : Press SET button 3 seconds, select PIN/ERR LED for setting and changing password in measurement mode if any error happens this LED will be on (If there are more than one error, errors' code is displayed by pressing SET button).
15. Up Button : Go to next menu or increase related value.
16. Esc Button : Exit from a menu. In the measurement mode, it is used to exit from harmonic menu.
17. Set Button : Enter to a menu or confirm the data entry. In the measurement mode, it is used to observe the harmonic values of current, voltage and power values.
18. Down Button : Go to the previous menu or decrease related value.
19. C+ LED : This LED represents that RG-B/BS is waiting for switching capacitor steps on.
20. Normal LED : This LED represents that RG-B/BS will not switch any capacitor steps on&off.
21. C- LED : This LED represents that RG-B/BS is waiting for switching capacitor steps off.
22. : If capacitor is not connected to the related step, "C+" lights is ON.
23. % : If reactive energy ratios exceed adjusted set values, "%" led lights.
24. : If voltage harmonic ratios exceed adjusted set values, "M" led lights.
25. V> : When the value of voltage exceeds adjusted set value or devices measured the value of voltage less than 30V or when devices can not measure current during auto setup, "V>" light is ON.
26. k LED : Represents measurement values with kilo unit (x10<sup>3</sup>).
27. M LED : Represents measurement values with mega unit (x10<sup>6</sup>).

# POWER FACTOR CONTROLLER RG-B/BS

## FAN

### Fan Relay Settings

This function is used for "switching-on" and "switching-off" the fan output contact according to measured temperature. There are two submenu as "F-on" and "F-oF".

**F-on** : This is the assignment menu for programming the switch-on temperature value. After a 10 sec. increasing of the high value of the temperature, contact is going to switched-on and fan led light will be on. Value can be defined between 00.0-99.8 °C. Function is going to be disabled in case of setting as "00.0", "F-oF" value will be 00.0 automatically.

**F-oF** : This is the assignment menu for programming the switch-off temperature value. Higher value of "F-on" can not be used.

### Monitoring the measured temperature

In order to make a correct measurement, device must keep worked at least 30 min. In order to observing the measured environmental temperature, press UP/DOWN buttons until flashing C°/Alarm LED.

## ALR

### Programmable Alarm Protection

These programs are set for protecting capacitors by user.

## UoL

### Over Voltage Protection Setup

Protecting capacitors from over voltage. It has 3 parameters.

**"SP-U"** : It can be programmed between 0-500 V. Setting to "0" means alarm is shutted down.

**"dELy"** : Delay time. It can be programmed between 0-9999 sec.

**"CAP"** : It shows step situation in alarm condition. Selecting "on" parameter protects capacitor steps. Selecting "oF" parameter switches off capacitor steps.

## THD

### Over THDV Protection Setup

Exceeding programmed THDV value situation, device gives alarm. It has 3 parameters.

**"SP-t"** : %THD can be set between 0-99.9. Setting to "0" means alarm is shutted.

**"dELy"** : Delay time. It can be programmed between 0-9999 sec.

**"CAP"** : It shows step situation in alarm condition. Selecting "on" parameter protects capacitor steps. Selecting "oF" parameter switches off capacitor steps.

## rAtE

### Ratio Protection Setup

Exceeding programmed inductive and capacitive ration in programmed time which was set by user, device give alarm. It has 3 parameters.

**"ind"** : Inductive ratio can be set between 0-99.9 %. Setting to "0" means alarm is shutted down.

**"CAP"** : Capacitive ratio can be programmed between 0-99.9 %. Setting to "0" means alarm is shutted down.

**"HoUr"** : Programmed between 1-240 hours.

**NOTE : Device shows "ind" and "CAP" ratios according to programmed "xxx" hour, so user only can see parameters last "xxx" hours.**

## HEAT

### Over Heat Protection Setup

Exceeding programmed temperature value which was set by user, device gives alarm after 10 sec. It has 3 parameters.

**"SP-H"** : Temperature alarm value can be set between 0-99.9 °C. Setting to "0" means alarm is shutted down.

**"SP-L"** : Back to temperature alarm value can be set between 0-99.9 °C. "SP-H" value must not be set as high value.

**"CAP"** : Determine the status of the alarm levels. Selecting "on" parameter protects capacitor step condition, selecting "oF" parameter switch off all capacitor steps.

## E-07

### Displaying the Alarm Codes which are given by the device

Related Alarm LED is on if any failure is occurred for any reason. When user request for monitoring the errors scrolling "UP/DOWN" buttons until displaying the "E-xx". This clause is not displayed if there is no error. All the error codes are displayed respectively by pressing the SET button. Example "E-07" means over voltage condition error.

## ALARM CODES

NO	DESCRIPTION	LED	REASON
00	-	-	-
01	-	-	-
02	Phase voltage don't exist	V>	Voltage terminal connections may be wrong
03	Phase current don't exist	V>	Current transformer connections for phase 1 may be wrong or first capacitor step may be defected
04	-	-	-
05	-	-	-
06	THD for voltage exceeds the present value		Excessive harmonic may be exist in the system
07	Voltage value of any phase exceeds the present menu	V>	Voltage value of the system may be increased
08	Reactive capacite ratio exceeds the present value	%	Compensation Error
09	Reactive inductive ratio exceeds the present value	%	Compensation Error
10	Temperature of capacitors exceeds the present value		Over Temperature
11	Automatic connection could not be found	V>	Defected capacitor step or variable loads
12	Over compensation		Target Cosφ is capacitive even if all capacitor steps are switched off
13	Insufficient compensation		Capacitor powers are not sufficient for target Cosφ
14	RST level sequencing is incorrect		3-Phase capacitor powers were not selected properly
15	-	-	-
16	-	-	-
17	-	-	-
18	Capacitor step 1 is defected		In the capacitor step measurement, 3-phase capacitor step is unbalanced or the fuse of any phase is blown
19	Capacitor step 2 is defected		In the capacitor step measurement, 3-phase capacitor step is unbalanced or the fuse of any phase is blown
20	Capacitor step 3 is defected		In the capacitor step measurement, 3-phase capacitor step is unbalanced or the fuse of any phase is blown
21	Capacitor step 4 is defected		In the capacitor step measurement, 3-phase capacitor step is unbalanced or the fuse of any phase is blown
22	Capacitor step 5 is defected		In the capacitor step measurement, 3-phase capacitor step is unbalanced or the fuse of any phase is blown
23	Capacitor step 6 is defected		In the capacitor step measurement, 3-phase capacitor step is unbalanced or the fuse of any phase is blown
24	Capacitor step 7 is defected		In the capacitor step measurement, 3-phase capacitor step is unbalanced or the fuse of any phase is blown
25	Capacitor step 8 is defected		In the capacitor step measurement, 3-phase capacitor step is unbalanced or the fuse of any phase is blown